

8611N

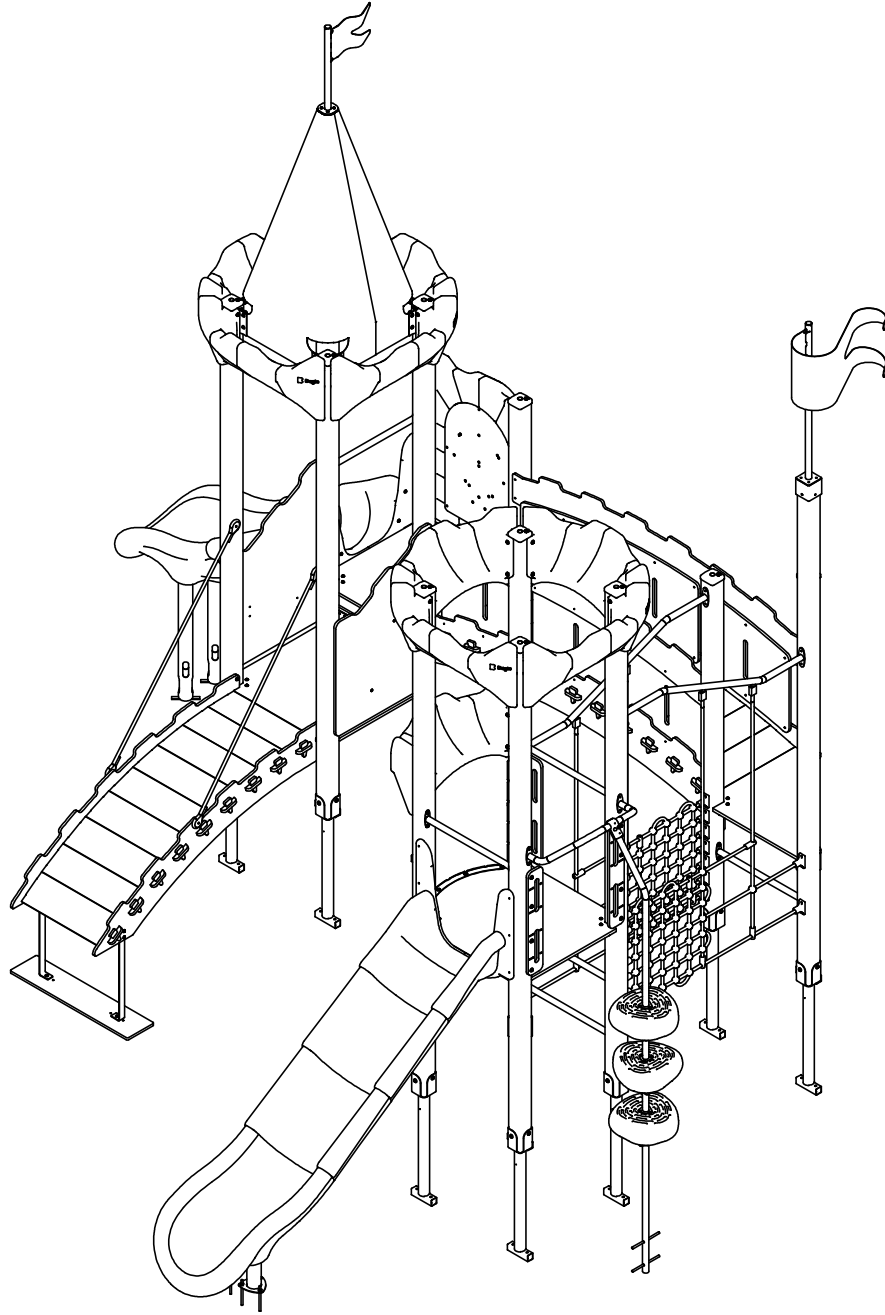

8611N

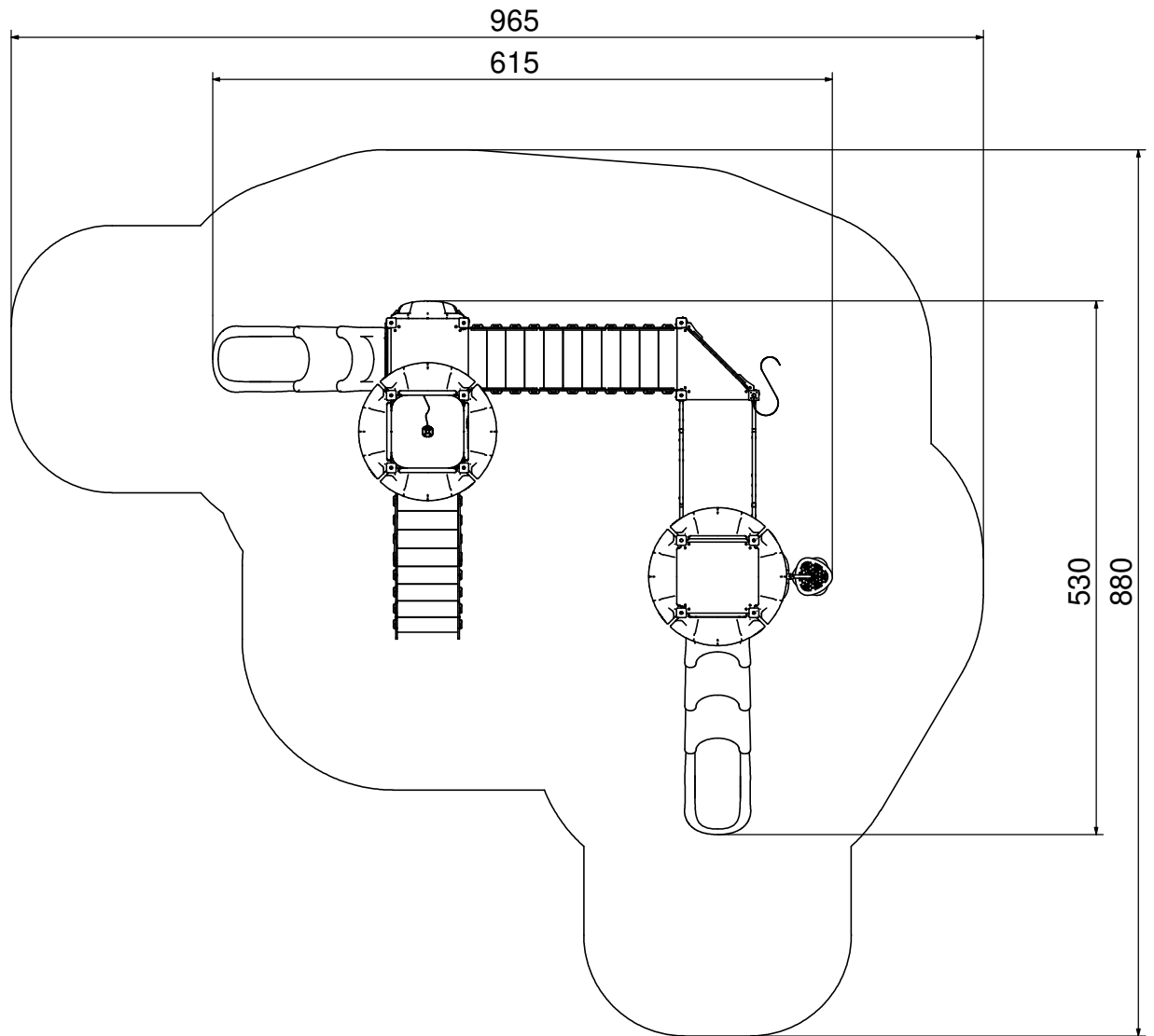
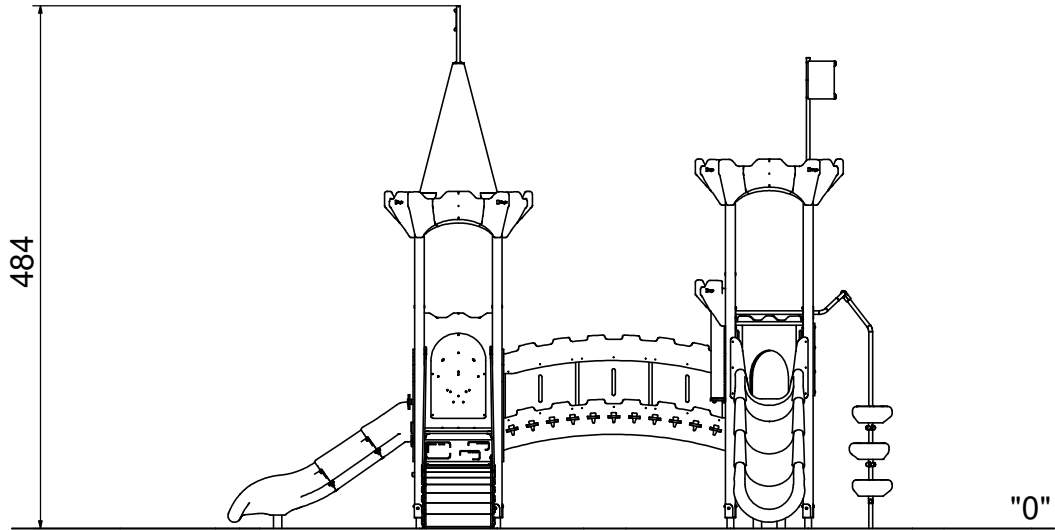

8611N

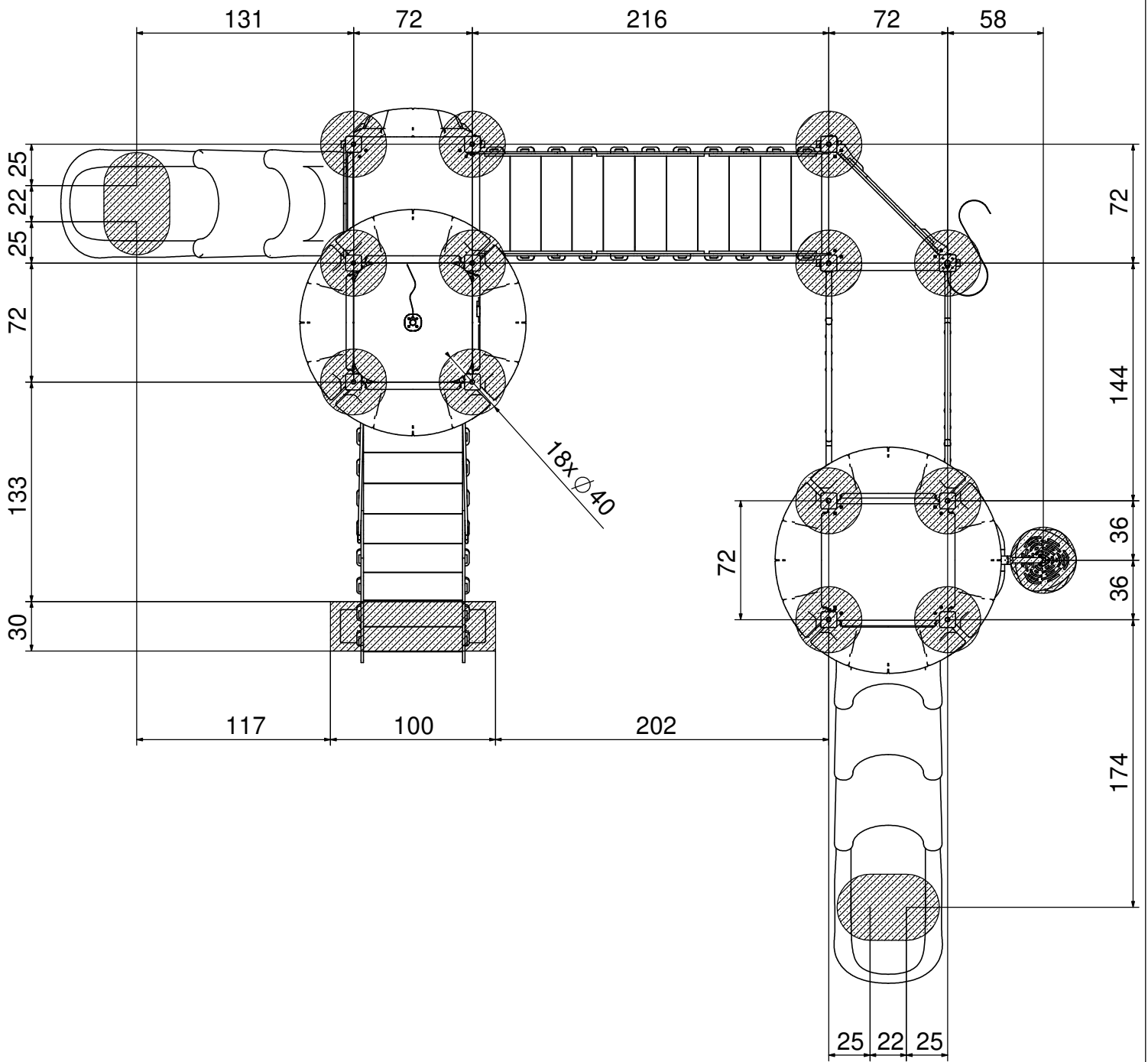

8611N

B25 0,5m³

min. 48H

